

USER'S GUIDE

Installation & Operation
Instructions

Differential Level Transmitter

Model DLT 2.0

Manual Series A.1.4

Note: This page has been left blank intentionally.

INDEX

CONNECTIONS: 4
KEYPAD SYSTEM..... 6
CALIBRATION MENU 7
ICONS..... 8
MAIN DISPLAY 9
MESSAGE ICON 9
STATUS 9
PASSWORD..... 10
UNITS/MODE..... 11
CALIBRATION..... 12
CHANNEL SETUP 16
RELAY PARAMETERS 17
SPECIAL FUNCTIONS 18
SENSOR MOUNTING/LOCATION 20
APPLICATIONS HOTLINE..... 26
PRODUCT RETURN PROCEDURE 27
APPENDIX A - OPTIONS..... 29
DATA LOGGING (Optional)..... 35
CONVERSION GUIDE 37
SPECIFICATIONS 38

IMPORTANT NOTE: This instrument is manufactured and calibrated to meet product specifications. Please read this manual carefully before installation and operation. Any unauthorized repairs or modifications may result in a suspension of the warranty.

Available in Adobe Acrobat pdf format

CONNECTIONS:

POWER INPUT: 100 to 240 VAC 50/60Hz . No adjustments are necessary for voltages within this range.

Optional DC: 9-32 VDC, 9 Watts. Connect to + and - terminals.

Optional Thermostat and Heater modules are available rated for 115 VAC or 230 VAC.

IMPORTANT NOTE: To comply with CSA/UL electrical safety standards, AC power input and relay connection wires must have conduit entry to the instrument enclosure. Installation requires a switch, overcurrent fuse or circuit breaker in the building (in close proximity to the equipment) that is marked as the disconnect switch.



Risk of electric shock. Loosen cover screw to access connections. Only qualified personnel should access connections.

Note: Use of instrumentation over 40°C ambient requires special field wiring.

Note: User replaceable fuse 2 Amp 250V (T2AL250V).

CONNECTIONS

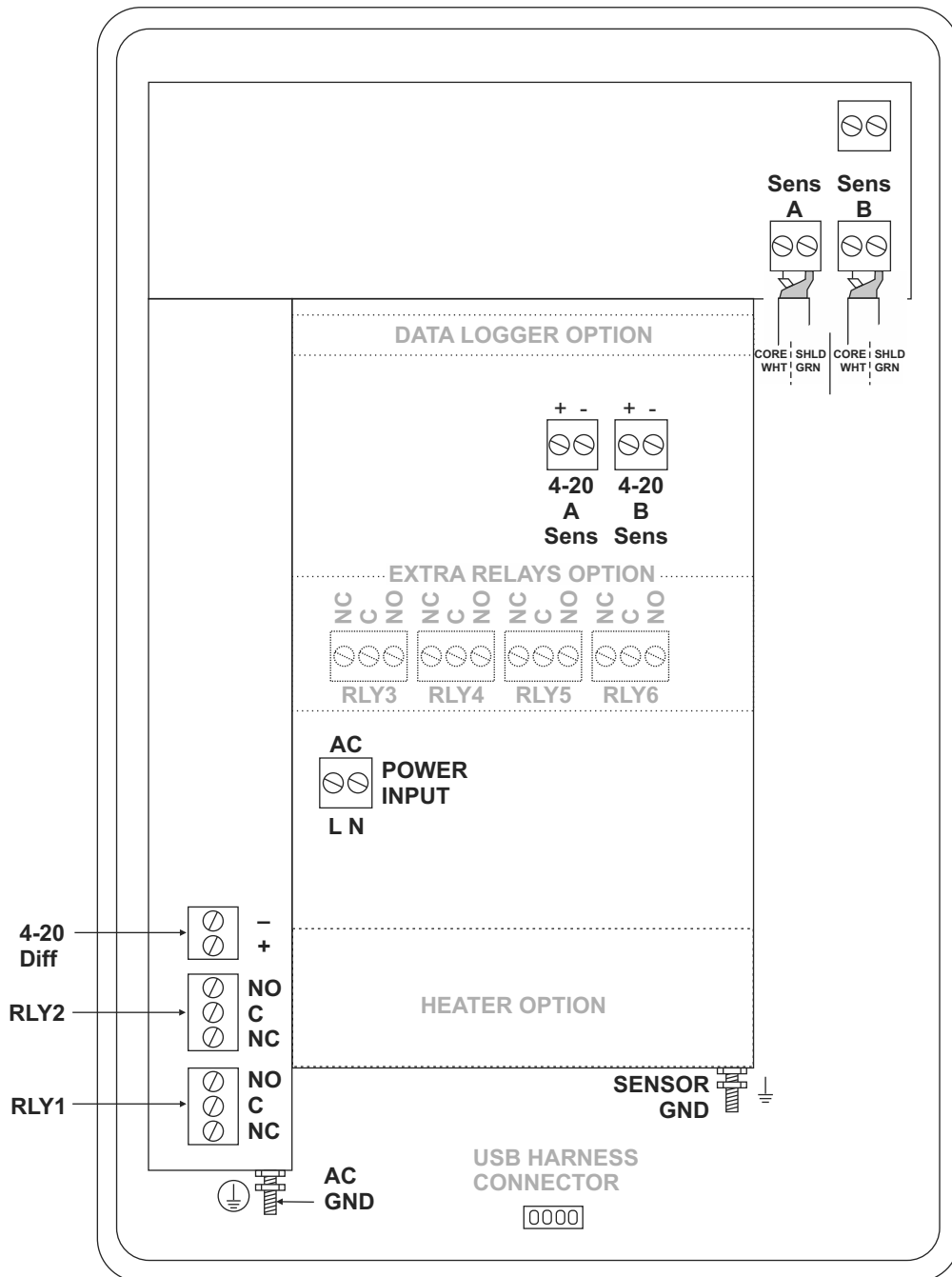

KEYPAD SYSTEM

The DLT 2.0 uses a menu system. Arrows show the four directions to leave a menu box. Press a key to move to the next item in the direction shown. Move the cursor (underline) under numerals and increase or decrease numerals with the **↑** and **↓** keys.

To store calibration values permanently (even through power interruptions), press **✓**.

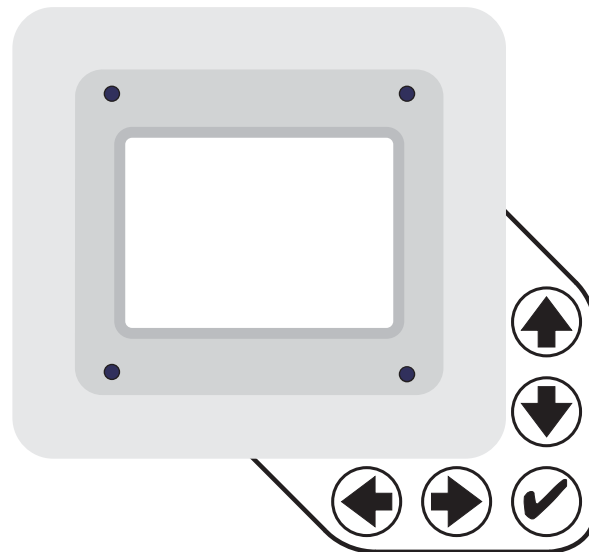

CALIBRATION MENU

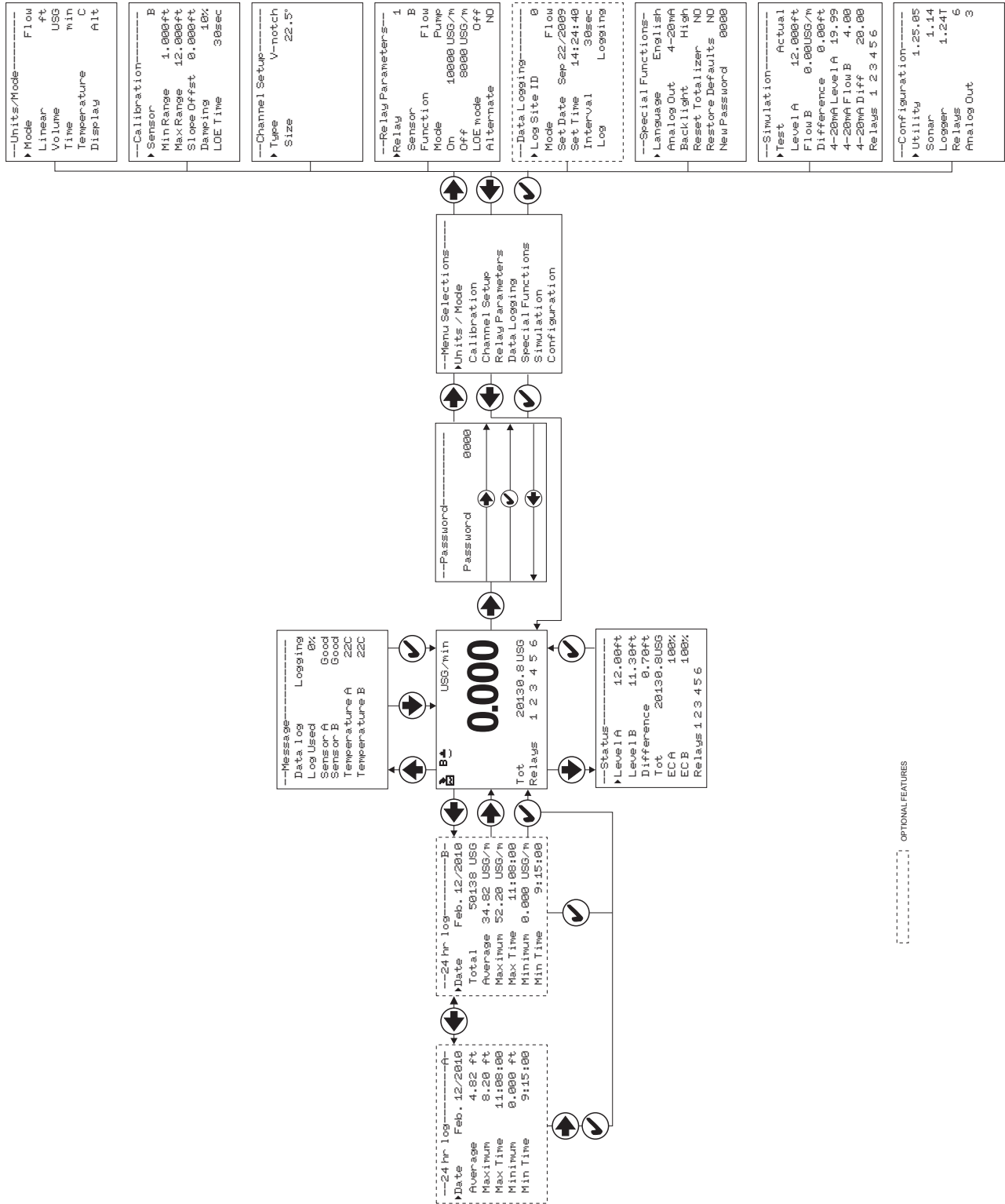

ICONS



1.



2.

Message waiting. Press .



Data logging off.



1.



2.

Data logging on.



1.



2.



3.



4.

USB file download.



File download completed.



Download Error.

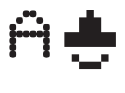

1.

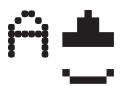

2.



3.

A sensor reading displayed. Echo OK.

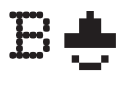

1.

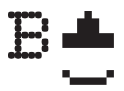

2.



3.

B sensor reading displayed. Echo OK.

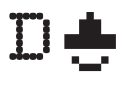

1.

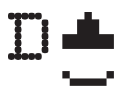

2.



3.

Difference reading displayed. Echo OK.



No Echo .

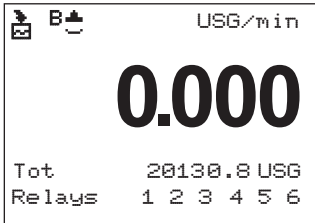

MAIN DISPLAY

NOTE

Sensor A reads Range, Level or Volume
Sensor B reads Range, Level, Volume HRT and Flow

The display is configured from “Units/Mode” menu to display the Sensor A measurement, Sensor B measurement or Level Difference. The DLT 2.0 will start-up with this display.

The display also shows Units Selected, Totalizer and Relay States.

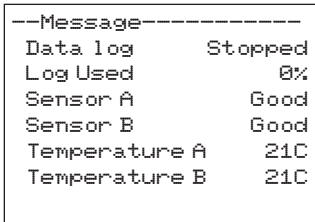

MESSAGE ICON

Press **↑** from the MAIN display to view status of the data logger and error/warning messages provided by the instrument. The Message Icon will appear on the MAIN display if error messages are being generated by the instrument. Press **✓** to return to the main display.

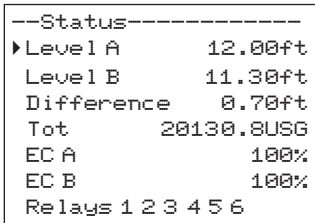

STATUS

Press **↓** from the MAIN display to view instrument status. **Level** for both sensors is displayed.

Tot Displays the current totalizer reading.

EC Displays echo confidence.

Relays Energized relays will display as a white character on a black background.

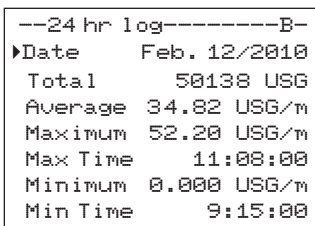

24 HR LOG (Data Logging option only)

Press **←** from the MAIN display to view a formatted flow report from instruments with a built-in data logger. Press **↓** to scroll down one day or repeatedly to scroll to a specific date. Press **←** to toggle between Sensor A and Sensor B formatted reports. Up to 365 days can be stored. Newest date will overwrite the oldest. Press **✓** to return to the main display.

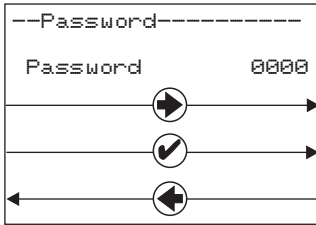

PASSWORD

The password (a number from 0000 to 9999) prevents unauthorized access to the Calibration menu.

From the MAIN display press **➡** to get to **Password**. Factory default password is **0000** and if it has not been changed press **✓** to proceed to the **Menu Selections** screen.

If a password is required, press **➡** to place the cursor under the first digit and **↓** or **↑** to set the number, then **➡** to the second digit, etc. Press **➡** or **✓** to proceed to the **Menu Selections** screen.

A new password can be stored by going to **Special Functions/New Password**.

```

--Units/Mode-----
▶Mode                Flow
Linear              ft
Volume             USG
Time               min
Temperature        C
Display           B
  
```

UNITS/MODE

From ▶Mode press the ➡ and then the ⬆ or ⬇ to select Level, Range, Flow, HRT or Volume.

Range displays distance from the sensors to the target or liquid surface like a tape measure. Range mode is useful to measure the exact distance from the sensors to the zero level during calibration.

Level used to measure tank levels and level difference in linear units, or "Head" in an open channel for comparison with flow tables.

Volume displays inventory of the two tanks in engineering units.

HRT select Horizontal Round Tank mode to calculate and display volume units in horizontal round tanks.

Flow calculates channel flow through a flume or weir (sensor B only). Sensor A measures level.

Volume, HRT or Flow gives the additional choice of volumetric units:

```

--Units/Mode-----
Mode                Flow
▶Linear             in
                  ft
                  m
                  mm
  
```

- ft3 - cubic feet
- USG - US gallons
- USMG - US million gallons (FLOW only)
- IG - Imperial gallons
- IMG - Imperial million gallons (FLOW only)
- m3 - cubic meters
- L - liters
- bb1 - U.S. oil barrel

```

--Units/Mode-----
▶Volume            USG
                  ft3
                  bbl
                  L
                  m3
                  IMG
                  IG
                  USMG
  
```

Press ✓ to store the selection, then ⬇ to the next menu item and ➡ to enter.

Linear press ➡ and then ⬆ or ⬇ to select units of measurement. Press ✓ to store the selection.

Time press ➡ and then ⬆ or ⬇ to select day, hr, min or sec.

Temperature press ➡ then ⬆ or ⬇ to select C or F (Centigrade or Fahrenheit)

Press ⬅ or ✓ to return to the Menu Selections screen.

```

--Units/Mode-----
Mode                Flow
Linear              in
Volume             USG
Time               min
▶Temperature        C
                  F
  
```

```

--Calibration-----
▶Sensor              B
Min Range           1.000ft
Max Range           12.000ft
Slope Offst         0.000ft
Damping              10%
LOE Time            30sec
  
```

CALIBRATION

Press **↓** to **▶Calibration** and **→** to enter. Use **↓** or **↑** to position **▶** before each menu item and **→** to enter. When settings are completed press **✓** to store and return to the **Calibration** menu.

Note - Sensors A & B do not need to be installed at the same height.

- Sensor** Select either Sensor A or Sensor B for calibration.
- Min Range** distance from the sensor face to highest expected level.
- Max Range** distance from the sensor face to channel floor.
- MaxVol** (Used for double tank monitoring applications, Volume and HRT mode only. Enter the maximum volume of the vertical or horizontal tank.

Note - to measure differential level the two sensors need a common reference assumed to be a level channel floor.

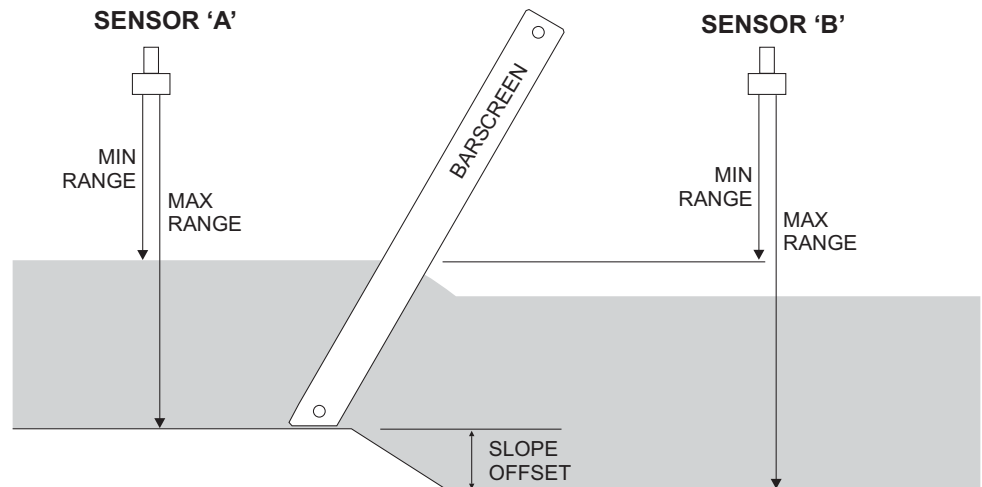

Slope Offst Appears when calibrating Sensor B. Enter a slope offset value to compensate for a sloped channel floor. Offset will be a positive value when Sensor B channel floor is lower than Sensor A channel floor.

Damping Minimum damping allows fast response to level changes. Increasing damping slows the DLT 2.0's response to level changes and is ideal to smooth the display and outputs in turbulent conditions. Damping value is shown in percent (0-99%). Some experimentation may be required to select the optimum damping value. A value of 1% is recommended for most applications and for fast level changes (up to 1/2 inch/sec - 13 mm/sec).

LOE Time - Appears when calibrating Sensor B. Press **➡** and **⬆** or **⬇** to change the number of seconds without receiving an echo before the DLT 2.0 displays ECHO LOSS, and Control relays change state as calibrated under Relay Parameters.

Factory default is 30 seconds and is recommended for most applications, Minimum is 1 second and maximum is 99 seconds.

Press **✓** from the **Units/Mode** display to return to Menu Selections.

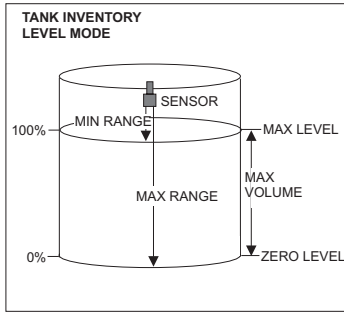

CALIBRATION

- for Level/Inventory Applications

1. Before starting the calibration determine:

- $MAX\ RANGE = \underline{\hspace{2cm}}$
(Maximum range = distance from Sensor to Zero level)
- $MAX\ LEVEL = \underline{\hspace{2cm}}$
(Maximum level of product being measured)
- $MIN\ RANGE = \underline{\hspace{2cm}}$
(Distance from sensor to Max Level)
Minimum range = $MAX\ RANGE - MAX\ LEVEL$
(must be at least 8" / 203 mm depending on sensor model)

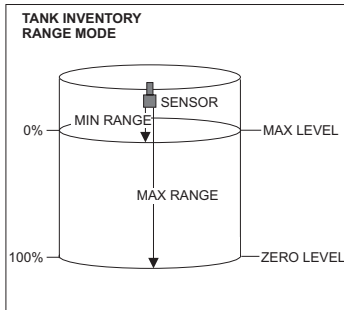

2. Check the maximum range with the sensor installed:

- When liquid is at zero level press \downarrow to view the Range reading in the Status menu. Use this range measured by the DLT 2.0 as the **Max Range** setting.
or
- Carefully measure distance from sensor to zero level with a tape measure, and use this measurement as the **Max Range** setting.

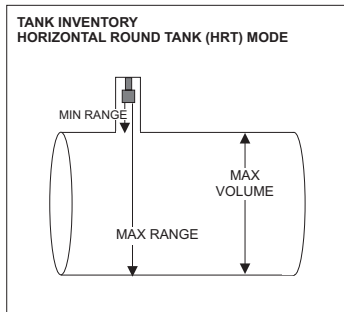

MINIMUM RANGE:

In the **CALIBRATION** menu:

- Press \downarrow to get to **Min Range**
- Press \rightarrow to move the cursor under the digits
- Use \downarrow or \uparrow to set the minimum range

Note: **Min Range** must be at least 12" (30.5 cm) for PZ32T sensors, 16" (40.6 cm) for PZ52T and PZ34 sensors and 8" for PZ15 sensors. For correct tank volume calculation in **Hrt** mode **Min Range** must be the actual distance from the end of the sensor to the top of the tank.

MAXIMUM RANGE:

Press \downarrow to get to **Max Range**
Enter **Max Range** determined above.

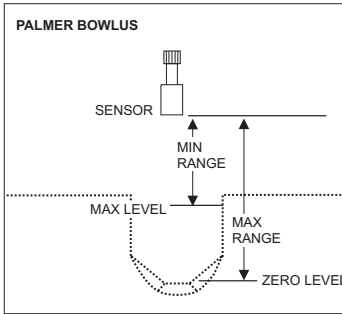

CALIBRATION - for Open Channel Flow

1. Before starting the calibration determine:

- a) **MAX RANGE** = _____
(Maximum range = distance from the Sensor to Zero flow point)
- b) **MAX LEVEL** = _____
(Maximum level of flow through flume or weir)
- c) **MIN RANGE** = _____
(Distance from sensor to Max Level)
Minimum range = MAX RANGE - MAX LEVEL
(must be at least 8" / 20.3 cm depending on sensor model).

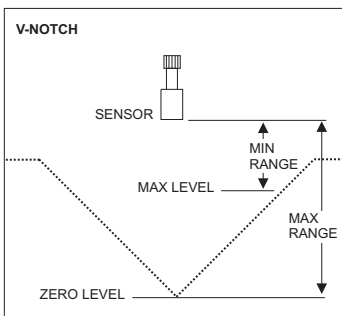

2. Check the maximum range with the sensor installed by:

- a) When liquid is at zero level press **↓** to view the **Range** reading in the **Status** menu. Use this range measured by the DLT 2.0 as the **Max Range** setting.
or
- b) Carefully measure distance from sensor to zero level with a tape measure, and use this measurement as the **Max Range** setting.

NOTE: The DLT 2.0 will not detect targets beyond user entered **Max Range**.

CHANNEL SETUP

```

--Channel Setup-----
▶Type      V-notch
           Custom
           Khafagi
           Rect Weir w/EC
           Rect Weir
           Trapezoidal
           Leopld-Lagco
           Palmer Bowlus
           Parshall
    
```

```

--Channel Setup-----
▶Type      V-notch
Size      22.5°
           120°
           90°
           60°
           45°
           30°
    
```

```

--Channel Setup-----
▶Type      Custom
K          0.0000
n          0.0000
    
```

```

--Channel Setup-----
▶Type      Khafagi
Height     0.000ft
    
```

```

--Channel Setup-----
▶Type      RECT Weir w/EC
Height     0.000ft
    
```

```

--Channel Setup-----
▶Type      RECT Weir
Height     0.000ft
    
```

```

--Channel Setup-----
▶Type      Trapezoidal
Size      Extra large 60°
           Large 60°
           Small 60°
           12in 45° SRCRC
           2in 45° WSC
           8in 60°
    
```

```

--Channel Setup-----
▶Type      Leopld-Lagco
Size      36in
           30in
           24in
           18in
           12in
           10in
           8in
           6in
    
```

```

--Channel Setup-----
▶Type      Palmer Bowlus
Size      48in
           42in
           36in
           30in
           27in
           24in
           21in
           18in
           15in
           12in
           10in
           8in
           6in
           4in
    
```

```

--Channel Setup-----
▶Type      Parshall
Size      12ft
           10ft
           8ft
           6ft
           5ft
           4ft
           3ft
           2ft
           18in
           12in
           9in
           6in
           3in
           2in
           1in
    
```



```
--Relay Parameters--
▶Relay          1
Sensor          Diff
Function        Flow
Mode            Pump
On              10000 USG/m
Off             8000 USG/m
LOE mode       Off
```

RELAY PARAMETERS

Relay Press **➡** and **⬇** or **⬆** to select a relay (2 relays are standard, 4 additional are optional).

Sensor Press **➡** and **⬆** or **⬇** to select **Sensor A**, **Sensor B** or **Level Difference**.

```
--Relay Parameters--
▶Relay          1
Function Temperature
On              0.0C
Off             9.0C
```

Function Press **⬇** or **⬆** to select **Off**, **Temperature**, **Pulse** and **Level**.

Temperature Air temperature at the sensor location. Press **⬇** and **➡** to set the relay On and Off for specific temperatures.

Pulse Press **⬇** and set digits to the flow volume increment required between relay pulses. Use this feature for remote samplers, chlorinators or totalizers. Minimum time between pulses is 2.25 seconds and pulse duration is 350 milliseconds.

```
--Relay Parameters--
▶Relay          1
Function        Pulse
On              10.000ft³
```

Level Appears in **Level**, **Range**, **Volume** or **HRT** modes only. Press **⬇** to **R Function** and **➡** to select **Pump**, **LoAlm** (low alarm) or **HiAlm** (high alarm).

Press **✓** to return to **Menu Selections**.

```
--Relay Parameters--
▶Relay          1
Function        Level
Mode            Pump
On              12.000ft
Off             3.000ft
LOE mode       Off
Alternate      NO
```

LOE Set relay state for 'echo loss' event (**On**, **Off** or **Hold**)

Alternate Pumps can be set to alternate when in pump mode.

DATA LOGGING (OPTIONAL)

Refer to Options section of this manual.

```
--Special Functions--
▶Language      English
Analog Out    4-20mA
Backlight     High
Reset Totalizer NO
Restore Defaults NO
New Password  0000
```

```
--Special Functions--
Language      English
▶Backlight    High
              Medium
              Low
              Key Hi/Lo
              Key High
              Key Med
              Key Low
              Off
```

SPECIAL FUNCTIONS

- Language** Select English, French or Spanish and press ✓.
- Analog Out** Select 4-20mA or 0-5V mode for the analog output.
- Backlight** Select High, Medium or Low for continuous backlight.
- Select Key Hi/Lo for high backlight (for 1 minute) after a keypress and then Lo backlight until a key is pressed again.
- Select Key High, Med or Low for backlight after a keypress and then backlight off until a key is pressed again.
- Reset Totalizer** Press ▶ and select Yes to erase and restart the totalizer at zero.
- Restore Defaults** Select Yes and press ✓ to erase all user settings and return the instrument to factory default settings
- New Password** Select any number from 0000 to 9999 and press ✓. Default setting of 0000 will allow direct access to the calibration menus. Setting of any password greater than 0000 will require the password to be entered to access the calibration menus.

Press ✓ to return to Menu Selections.

```
--Simulation-----  
▶Test           Actual  
Level A        116.74in  
Level B         62.11in  
Difference      54.63in  
4-20mA Level A  18.15  
4-20mA Level B  11.53  
4-20mA Diff     10.62  
Relays 1 2 3 4 5 6
```

SIMULATION

Exercises the 4-20mA (0-5V) outputs, digital display and control relays.

Test Select **Maximum** and press ✓ to simulate maximum Flow, Range or Level and to output 20mA (5V) for each analog channel.

Select **Minimum** and press ✓ to simulate minimum Flow, Ranges or Levels and to output 4mA (0V) for each analog channel.

To simulate measurements between minimum and maximum set **Test** to **Actual** and then enter values for the **A** and **B** measurement. The differential calculation, analog outputs and control relays will respond to the simulated values.

SENSOR MOUNTING/LOCATION
- Tank Level/Inventory Applications

Each DLT 2.0 Level Transmitter includes two non-contacting ultrasonic sensors. The sensors must be installed in a position to obtain unobstructed echoes from the liquid or material being measured.

Mount the sensor away from pipes, ladders, or structural members which might cause continuous false echoes.

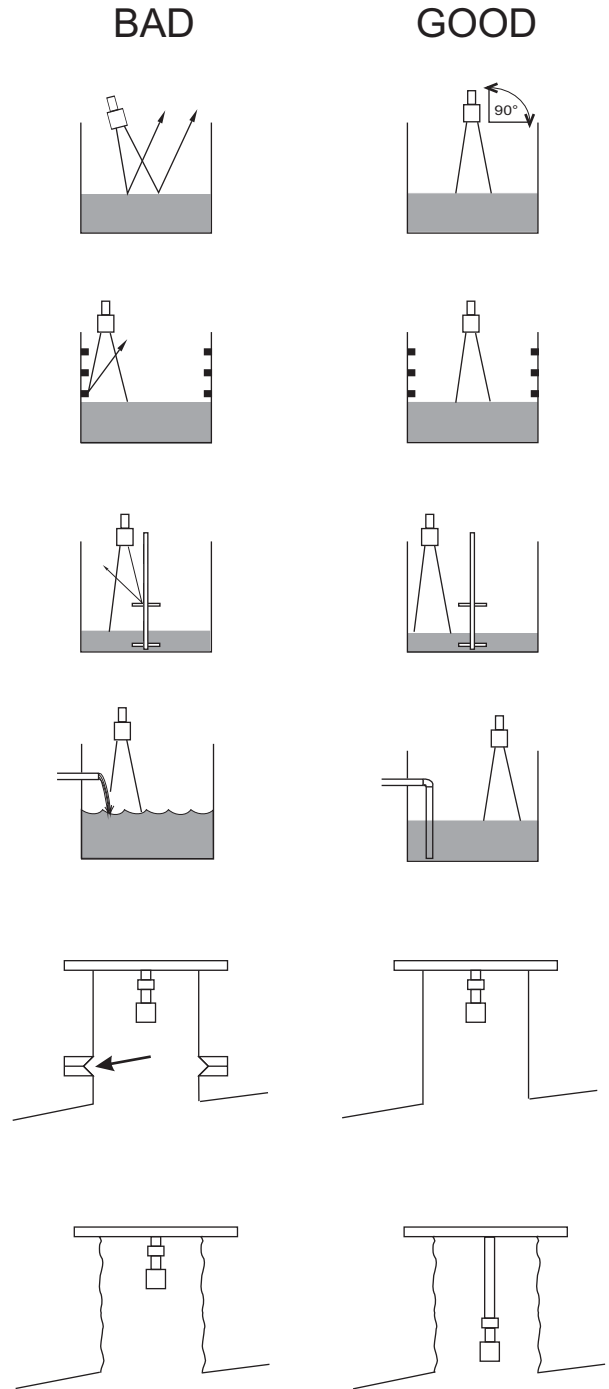

SENSOR MOUNTING LOCATION - Tank Level/Inventory Applications

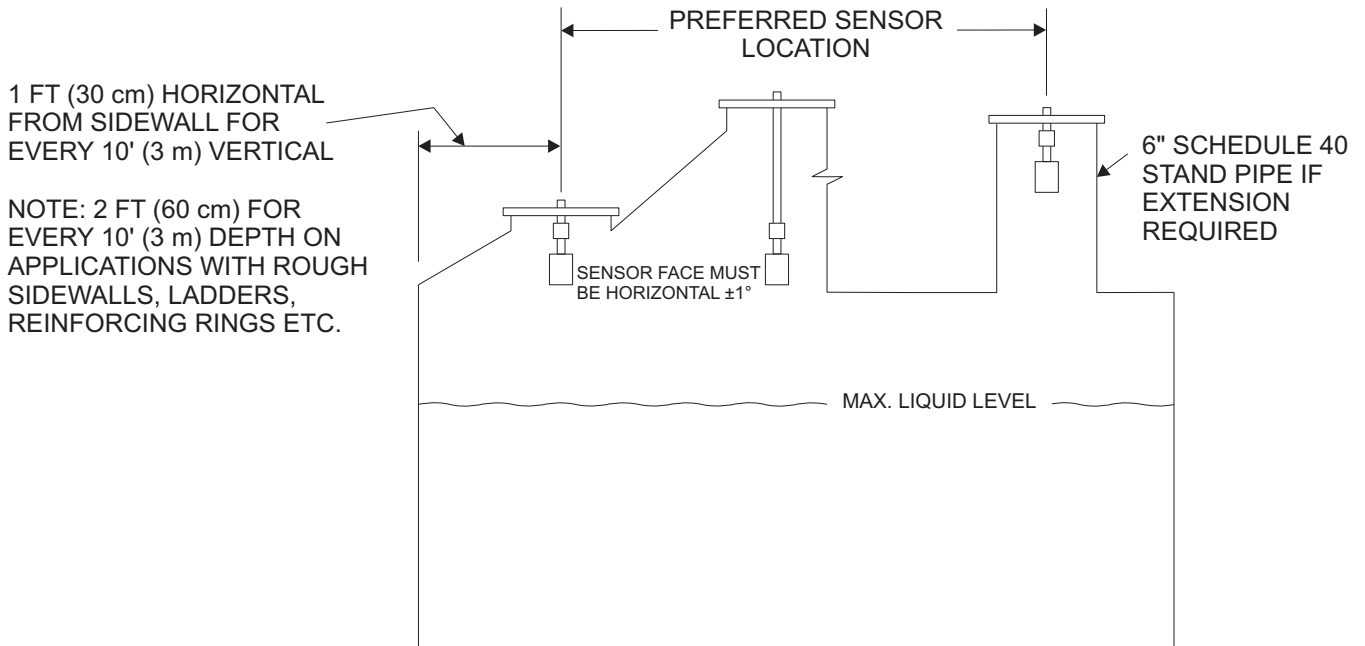

SENSOR MOUNTING

Each sensor is equipped with a $\frac{3}{4}$ inch "isolation coupling" which **MUST** be used in your installation. A threaded nipple or length of conduit may be used to position the sensor at the desired height.

The sensor should be hand-tightened (like a light bulb) by turning the sensor stem only. **DO NOT** use a wrench and do not over tighten. **DO NOT** clamp the sensor below the isolation coupling.

TYPICAL SENSOR POSITIONING FOR FLUMES AND WEIRS

Always refer to the flume or weir manufacturer's instructions for correct measurement point upstream from the flume or weir. Location of the sensor is critical for accurate flow measurement.

If manufacturer's instructions are not available, the following guidelines are generally accepted.

1. PARSHALL FLUME:

Position the sensor at $\frac{2}{3}$ Approach as illustrated above. Sensor height must be 8" (203 mm) or more above the highest water level.

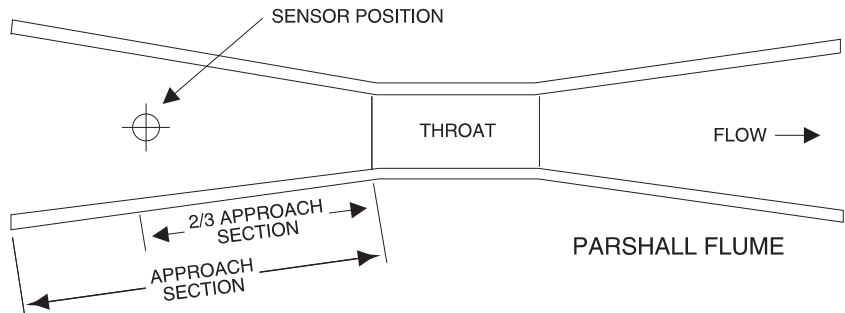

2. PALMER BOWLUS FLUMES:

Position the sensor at $\frac{1}{2}$ the flume Diameter upstream from the throat of the flume. Sensor height must be 8" (203 mm) or more above the highest water level.

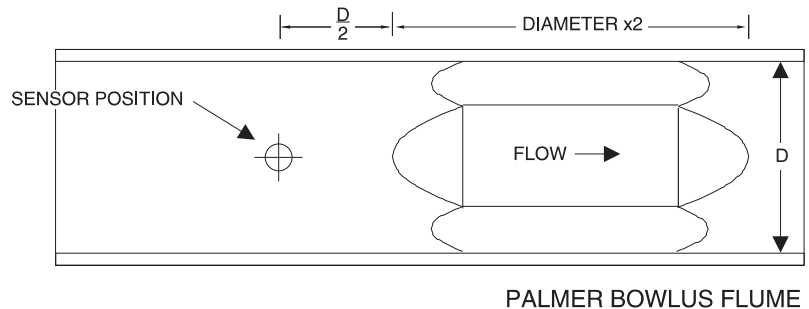

3. V-NOTCH WEIRS

Position the sensor at 3 x maximum Head upstream from the weir plate. Sensor height must be 8" (20.3 cm) or more above the highest water level.

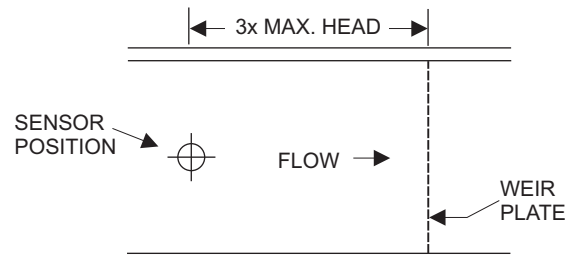

STILLING WELLS

Stilling wells are recommended to reduce the effects of turbulence as water flows through the flume or weir. The DLT 2.0 sensor is centered over the stilling well. Sensor height must be 8" (203 mm) or more above the highest water level. The well must be kept clean of sediment and deposits on the side walls.

ENCLOSURE INSTALLATION

Locate the enclosure within 20 ft (6 m) of the sensor (500 ft -150 m optional). The enclosure can be wall mounted with the four mounting screws (included) or panel mounted with Option PM Panel Mount kit from Greyline Instruments.

Avoid mounting the enclosure in direct sunlight to protect the electronics from damage due to overheating and condensate. In high humidity atmospheres, or where temperatures fall below freezing, Option TH Enclosure Heater and Thermostat is recommended. Seal conduit entries to prevent moisture from entering enclosure.

NEMA4X (IP66) WITH CLEAR COVER

1. Open hinged enclosure cover.
2. Insert #8 screws (supplied) through the four enclosure mounting holes to secure the enclosure to the wall or mounting stand.

Additional conduit holes can be cut in the bottom of the enclosure when required. Use a hole saw or Greenlee-type hole cutter to cut the required holes.

DO NOT make conduit/wiring entries into the top of the enclosure.

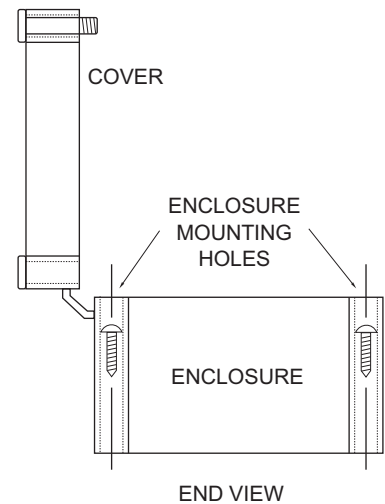

Note: This non-metallic enclosure does not automatically provide grounding between conduit connections. Grounding must be provided as part of the installation. Ground in accordance with the requirements of the National Electrical Code. System grounding is provided by connecting grounding wires from all conduit entries to the steel mounting plate or another point which provides continuity.

CLEANING

Cleaning is not required as a part of normal maintenance.

PZxx Series Sensors

Troubleshooting

Resistance measured (between the shield and center wire) across the coaxial cable ends by multimeter indicates ambient temperature.

Resistance vs. Temperature

Values are in Ohms

Temp °C	+0	+1	+2	+3	+4	+5	+6	+7	+8	+9
0	10000.0	10039.0772	10078.1429	10117.1970	10156.2396	10195.2706	10234.2901	10273.2980	10312.2944	10351.2792
10	10390.2525	10429.2142	10468.1644	10507.1030	10546.0301	10584.9456	10623.8496	10662.7420	10701.6229	10740.4922
20	10779.3500	10818.1962	10857.0309	10895.8540	10934.6656	10973.4656	11012.2541	11051.0310	11089.7964	11128.5502
30	11167.2925	11206.0232	11244.7424	11283.4500	11322.1461	11360.8306	11399.5036	11438.1650	11476.8149	11515.4532
40	11554.0800	11592.6952	11631.2989	11669.8910	11708.4716	11747.0406	11785.5981	11824.1440	11862.6784	11901.2012
50	11939.7125									

© 2009 Minco, All Rights Reserved

Values are in Ohms

Temp °F	+0	+1	+2	+3	+4	+5	+6	+7	+8	+9
30			10000.0	10021.7110	10043.4184	10065.1223	10086.8226	10108.5193	10130.2125	10151.9021
40	10173.5881	10195.2706	10216.9495	10238.6249	10260.2967	10281.9649	10303.6295	10325.2906	10346.9481	10368.6021
50	10390.2525	10411.8993	10433.5426	10455.1823	10476.8184	10498.4510	10520.0800	10541.7054	10563.3273	10584.9456
60	10606.5604	10628.1716	10649.7792	10671.3832	10692.9837	10714.5806	10736.1740	10757.7638	10779.3500	10800.9327
70	10822.5118	10844.0873	10865.6593	10887.2277	10908.7925	10930.3538	10951.9115	10973.4656	10995.0162	11016.5632
80	11038.1067	11059.6466	11081.1829	11102.7156	11124.2448	11145.7704	11167.2925	11188.8110	11210.3259	11231.8373
90	11253.3451	11274.8493	11296.3500	11317.8471	11339.3406	11360.8306	11382.3170	11403.7999	11425.2792	11446.7549
100	11468.2270	11489.6956	11511.1606	11532.6221	11554.0800	11575.5343	11596.9851	11618.4323	11639.8759	11661.3160
110	11682.7525	11704.1854	11725.6148	11747.0406	11768.4629	11789.8816	11811.2967	11832.7082	11854.1162	11875.5206
120	11896.9215	11918.3188	11939.7125							

© 2009 Minco, All Rights Reserved

FUSE REPLACEMENT

1. Turn OFF power.
2. Loosen cover screw and open.
3. Remove power module.
4. Locate fuse on Power Board.
5. Replace fuse with 2 AMP/ 250V, 5 x 20mm fuse.
6. Reinstall power module into chassis.

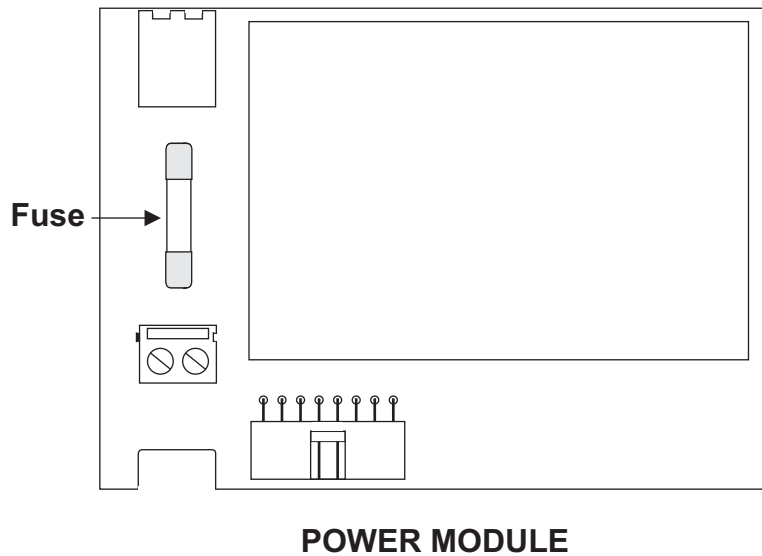



APPLICATIONS HOTLINE

For applications assistance, advice or information on any Greyline Instrument contact your Sales Representative, write to Greyline or phone the Applications Hotline below:

United States:	Tel: 315-788-9500	Fax: 315-764-0419
Canada:	Tel: 613-938-8956	Fax: 613-938-4857
Toll Free:	888-473-9546	
Email:	info@greyline.com	
Web Site:	www.greyline.com	

Greyline Instruments Inc.

Canada
16456 Sixsmith Drive
Long Sault, Ont. K0C 1P0

USA:
105 Water Street
Massena, NY 13662

PRODUCT RETURN PROCEDURE

Instruments may be returned to Greyline for service or warranty repair.

1) Obtain an RMA Number from Greyline -

Before shipping a product to the factory please contact Greyline by telephone, fax or email to obtain an RMA number (Returned Merchandise Authorization). This ensures fast service and correct billing or credit.

When you contact Greyline please have the following information available:

1. Model number / Software Version
2. Serial number
3. Date of Purchase
4. Reason for return (description of fault or modification required)
5. Your name, company name, address and phone number

2) Clean the Sensor/Product -

Important: unclean products will not be serviced and will be returned to the sender at their expense.

1. Rinse sensor and cable to remove debris.
2. If the sensor has been exposed to sewage, immerse both sensor and cable in a solution of 1 part household bleach (Javex, Clorox etc.) to 20 parts water for 5 minutes. Important: do not immerse open end of sensor cable.
3. Dry with paper towels and pack sensor and cable in a sealed plastic bag.
4. Wipe the outside of the enclosure to remove dirt or deposits.
5. Return to Greyline for service.

3) Ship to Greyline -

After obtaining an RMA number please ship the product to the appropriate address below:

Canadian and International
Customers:

Greyline Instruments Inc.
16456 Sixsmith Drive
Long Sault, Ont. K0C 1P0

RMA#

USA
Customers:

Greyline Instruments Inc.
204 150th Avenue
Madeira Beach, FL 33708

RMA#

LIMITED WARRANTY

Greyline Instruments warrants, to the original purchaser, its products to be free from defects in material and workmanship for a period of one year from date of invoice. Greyline will replace or repair, free of charge, any Greyline product if it has been proven to be defective within the warranty period. This warranty does not cover any expenses incurred in the removal and re-installation of the product.

If a product manufactured by Greyline should prove defective within the first year, return it freight prepaid to Greyline Instruments along with a copy of your invoice.

This warranty does not cover damages due to improper installation or handling, acts of nature, or unauthorized service. Modifications to or tampering with any part shall void this warranty. This warranty does not cover any equipment used in connection with the product or consequential damages due to a defect in the product.

All implied warranties are limited to the duration of this warranty. This is the complete warranty by Greyline and no other warranty is valid against Greyline. Some states do not allow limitations on how long an implied warranty lasts or limitation of incidental or consequential damages, so the above limitations or exclusions may not apply to you.

This warranty gives you specific legal rights, and you may also have other rights which vary from state to state.

Greyline Instruments Inc.

APPENDIX A - OPTIONS

EXTRA SENSOR CABLE - OPTION XC

Each Greyline level instrument includes 25 ft. (7.6 m) RG62AU coaxial cable. Additional RG62AU coaxial cable and Cable Junction Box (Option JB4X) may be installed to extend cable up to 500 ft (152m) as required during installation. No adjustment is required when the sensor cable is extended or shortened. Use only RG62AU (or RG62U) coaxial cable which is available from Greyline Instruments or your local distributor. Nominal impedance of RG62AU cable is 93 ohms.

Extended sensor cable maybe installed in metal or plastic conduit. Recommended installation with a junction box is illustrated below:

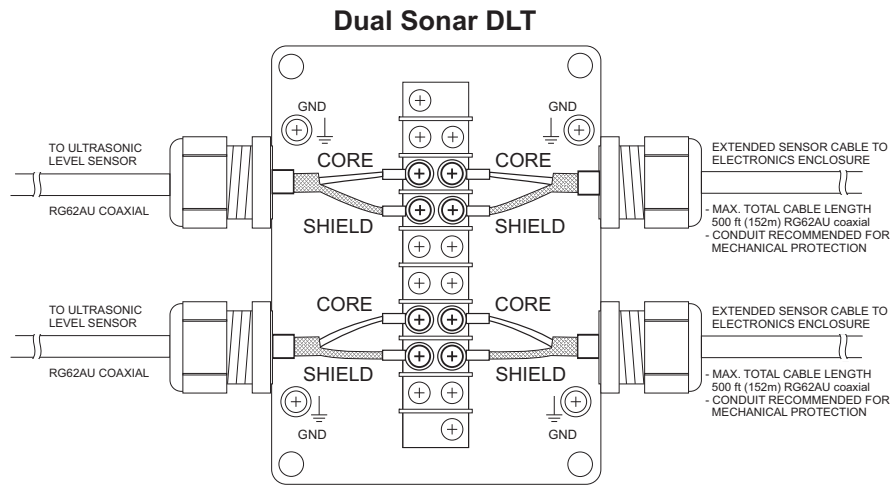

JUNCTION BOX - OPTION JB4X

NEMA4X (IP66) polycarbonate Junction Box with terminal strips is available from Greyline Instruments. Includes compression fittings for watertight coaxial cable entries.

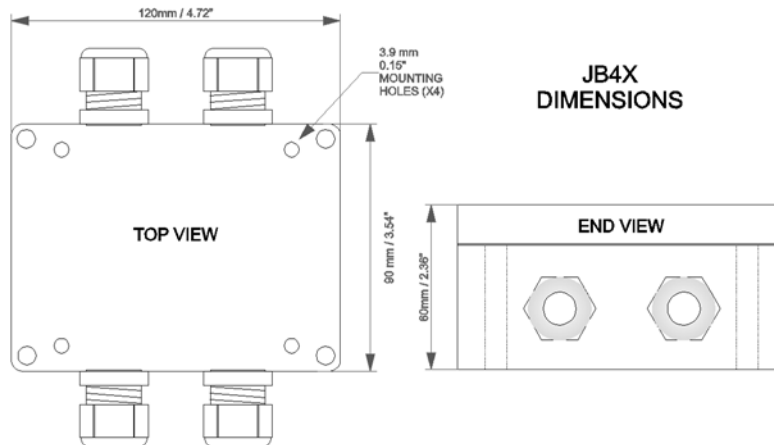

EXTENDED SENSOR CABLE INSTALLATION IN MANHOLE

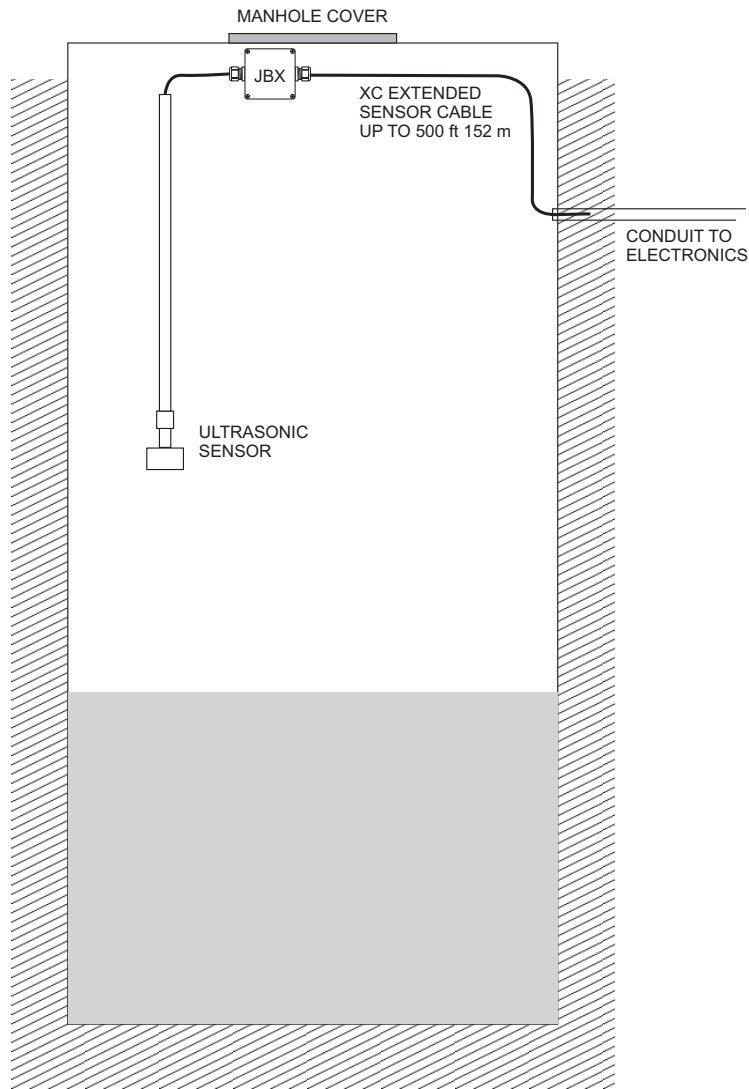

Wetwell, Sump or Pump Station

**SENSOR INTRINSIC SAFETY
(OPTION ISB)**

When connected through Intrinsic Safety Barriers, Greyline PZ** Series sensors are certified for installation in a hazardous location rated:

Class I, Groups C,D
Class II, Groups E,F,G
Class III

The Intrinsic Safety Barrier may be ordered with the Greyline instrument and is supplied mounted in the Greyline instrument enclosure. Replacement barrier fuses (Part No. ISB- 011239) may be purchased separately. The instrument enclosure containing the ISB Intrinsic Safety Barrier must be installed in a non-hazardous location.

GN3SPEC-ISB-04

The intrinsic safety barrier assemblies installed in the DLT 2.0 limit the voltage and current supplied to the transducers to the values listed under 'Barrier Specifications'. To safely install Greyline transducers certified for use in hazardous locations you must refer to the installation drawings/specifications of the certified transducers.

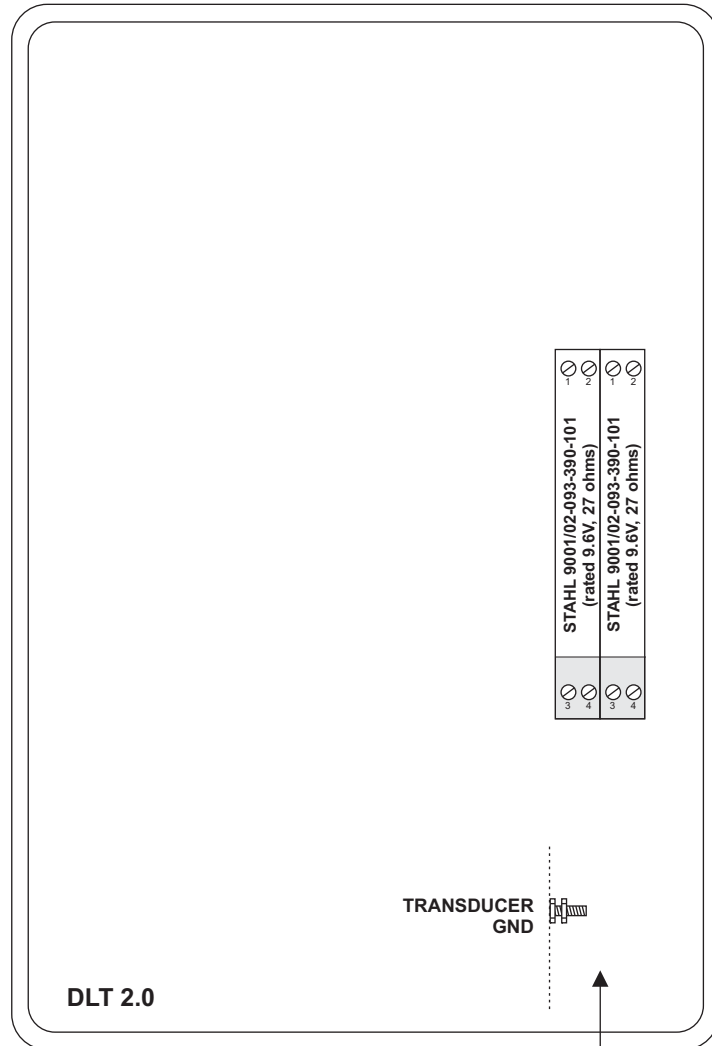

Installed in
Non-Hazardous Location

BARRIER SPECIFICATIONS

STAHL BARRIER	System Parameters	Entity Parameters					
		U_m	V_{0c}	I_{sc}	P_0	C_a	L_a
9001/02-093-390-101	9.6V, 27 ohms	250V	9.3V	390mA	906.8mW	4.1 μ F	0.16mH

ENCLOSURE HEATER AND THERMOSTAT - Option TH

Instruments can be factory-equipped with an Enclosure Heater and Thermostat or the module can be customer-installed. The Thermostat is factory set to turn ON at 40°F (4.5°C) and OFF at 60°F (15.5°C). Power consumption is 15 Watts.

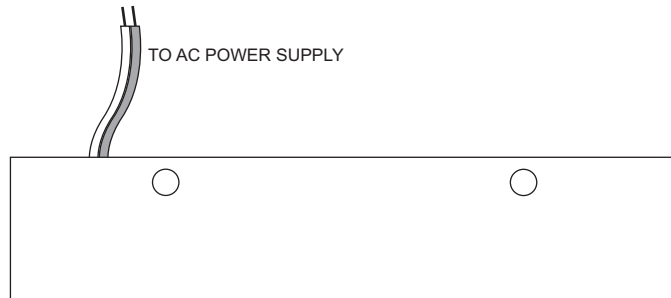

ENCLOSURE SUNSCREEN - Option SCR

Do not mount instrument electronics in direct sunlight. Overheating will reduce the life of electronic components and condensate may form during the heat/cool cycles and cause electrical shorts.

Note:

Exposure to direct sunlight can cause overheating and moisture condensation which will reduce the operating life of electronics.

Protect Instruments from direct sunlight with this iridite finished aluminum sun screen (Greyline Option SCR).

Seal conduit entries with caulking compound to further reduce moisture condensation.

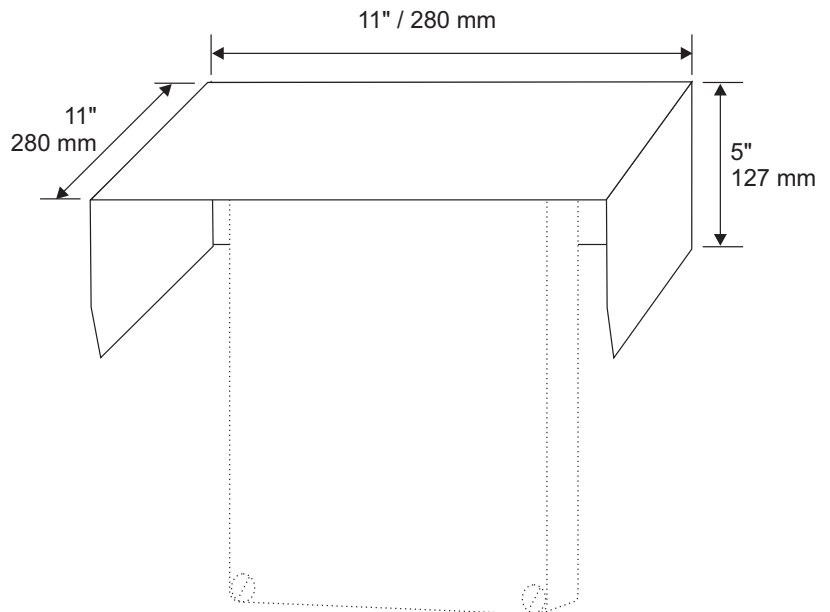

**POWER INPUT OPTION
9-32VDC**

DLT 2.0 Differential Level Transmitters may be ordered factory-configured for 9-32VDC power input.

QUICK BENCH TEST:

Connect Sensor as shown below, then Power. When properly connected figures will show on the large LCD display. Test operation of the DLT 2.0 by holding the sensor steadily and aiming at a flat, stable target 12 to 28" (305 to 711 mm) away from the end of the sensor. Allow a few seconds for the DLT 2.0 to lock onto the target before displaying its distance. The DLT 2.0 will now display Range in ft or cm (factory calibration).

CONNECTIONS:

POWER INPUT: Connect 9-32VDC/0.5 Amps to the + and - terminals. The Power Input GND must be connected to the nearest Ground pole. A 1 amp fuse in line is recommended.

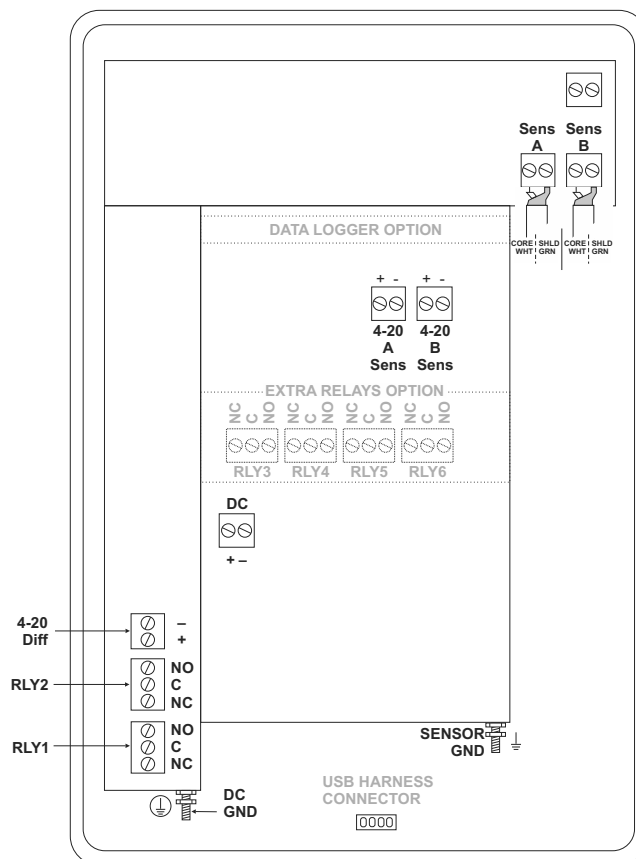

DATA LOGGING (Optional)

Setup

Select Data Logging from Menu Selections.

Log Site ID Enter a number from 00 to 99. The site ID will become part of the downloaded file name to help distinguish downloads from different instruments. Press ✓ to store the setting.

Mode Select Level, Range, Flow, HRT or Volume and press ✓ to store the setting. The logger will auto-configure for 2 or 3 channel logging according to the selected mode:

Flow - 3 channels: A Level
B Flow
Differential

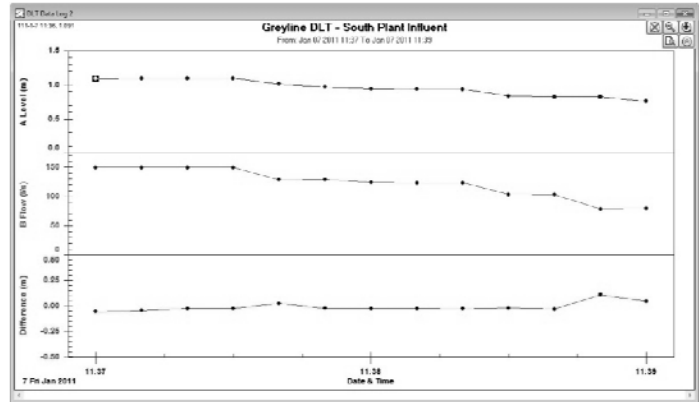

Level - 3 channels A Level
B Level
Differential

Range - 2 channels A Range
B Range

HRT & Vol - 2 channels A Volume
B Volume

Set Date Press ↑ or ↓ to scroll and select Month, Day and Year. Press ✓ to store the setting.

Set Time Press ↑ or ↓ to select the current time in Hours, Minutes and Seconds. Press ✓ to store the setting.

Interval Press **↑** or **↓** to select the logging interval. Press **✓** to store the setting.

Log Stop, Start or Delete the log file.
Press **↑** or **↓** to Delete and **✓** to delete the log file.
Press **↑** or **↓** to Start and **✓** to start the logger.

Note: You MUST delete old log and start a new log AFTER having set changes to Log Site ID, Mode and/or Interval for those changes to be applied to the log file.

RETRIEVE LOG FILE

Plug a USB Flash Memory Drive (not supplied by Greyline) into the USB output cable from the instrument. The instrument display will show the USB file download icon until the log file is transferred to the memory card and then display file download completed icon. The USB flash drive may be removed.

Download file names will appear in this format:

DLT_ _00A.LOG
↑ ↑ ↑
MODEL TAG DOWNLOAD

Tag is set according to the Log Site ID entered in the instrument Data Logging menu.

Download letter will be A for the first download from an instrument. B for the second, then C etc. At the letter Z a - character will appear indicating that the maximum number of downloads for that instrument are on the USB flash drive. Older files can be erased or moved from the flash memory drive or a new memory drive can be used.

OPENING LOG FILES

Install Greyline Logger on your PC or laptop. Refer to the Help menu in the program for detailed instructions.

Select File/Open/Instrument Log (.log) to open the log file from your USB flash drive.

CONVERSION GUIDE		
FROM	TO	MULTIPLY BY
US GALLONS	CUBIC FEET	0.1337
US GALLONS	IMPERIAL GALS	0.8327
US GALLONS	LITRES	3.785
US GALLONS	CUBIC METERS	0.003785
LITRES/SEC	GPM	15.85
LITRES	CUBIC METERS	0.001
BARRELS	US GALLONS	42
BARRELS	IMPERIAL GALS	34.9726
BARRELS	LITRES	158.9886
INCHES	MM	25.4
DEGREES F	DEGREES C	(°F-32) x 0.556
POUNDS	KILOGRAMS	0.453
PSI	BAR	0.0676
FOOT ²	METER ²	0.0929

VOLUME CALCULATION FOR ROUND TANKS: $3.142 \times R^2 \times H$
R = TANK RADIUS (½ TANK DIAMETER)
H = TANK HEIGHT

SPECIFICATIONS

Accuracy:	0.25% F.S., Repeatability: 0.1% F.S., Linearity: 0.1%F.S.
Displays:	White, backlit matrix - displays flow rate, totalizer, relay states, operating mode and calibration menu
Calibration:	built-in 5-key calibrator with English, French or Spanish language selection
Power Input:	100-240VAC, 50/60Hz, 30 Watts or 9-32VDC, 9 Watts max
Output:	Isolated 4-20mA (1000 ohm load max.)
Control Relays:	Qty 2, rated 5 amp 240VAC SPDT, programmable flow alarm and/or proportional pulse
Enclosure:	watertight, dust tight NEMA4X (IP 66) polycarbonate with a clear shatter-proof face
Environmental Conditions:	Relative humidity up to 80% -23 to 60°C ambient temperature, maximum 5000 m altitude, pollution degree 4, Installation Category II.
Sensitivity:	adjustable. Damping: adjustable
Electrical Surge Protection:	Sensor, 4-20mA output and AC power input
Approximate Shipping Weight:	10 lbs (4.5 kg)

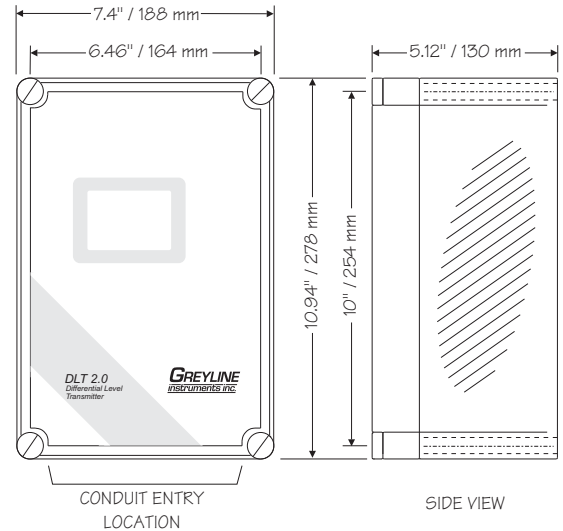

Standard Sensor PZ15

Maximum Range:	15 ft (4.57 m)
Minimum Range (Deadband):	8" (203.2 mm)
Operating Frequency:	92 KHz
Beam Angle:	8°
Operating Temperature:	-40° to 150° (-40° to 65°C)
Temperature Compensation:	Automatic, continuous
Max. Operating Pressure:	20 psi (1.35 bar)
Sensor Face:	PVC
Sensor Body:	PVC
Mounting:	3/4" NPT
Cable Length:	25 ft. (7.6 m) continuous RG62AU coaxial. Optional 50 ft. (15 m) continuous
Max. Cable Length:	500 ft. (152 m) RG62AU coaxial (splice)
Hazardous Rating:	CSA rated Intrinsically Safe Class I, Groups C,D, Class II, Groups E,F,G with Optional Intrinsic Safety Barrier.

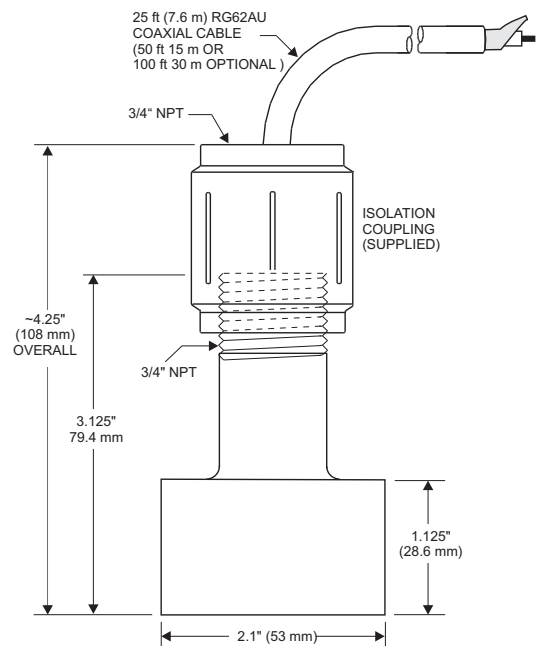

Optional PZ34

Maximum Range: 32 ft. (10 m)
Minimum Range (Deadband): 16" (406.4 mm)
Operating Frequency: 46 KHz
Beam Angle: 8°
Temperature Compensation: Automatic, continuous
Operating Temperature: -40° to 150°F (-40° to 65°C)
Maximum Operating Pressure: 20 psi (1.35 Bar)
Exposed Materials: PVC
Sensor Mounting: 3/4" NPT
Maximum Cable Length: 500 ft (152 m)
Optional Hazardous Rating: CSA rated Intrinsically Safe Class I, Groups C,D, Class II, Groups E,F,G with optional Intrinsic Safety Barrier.
 Note: Max Range reduced to 25 ft (7.8 m) with ISB option.

